

# Microframe Corporation

Series 904:  
2, 3, or 4-Digit  
Visual-Paging System



**Operating Manual**

A1030-7011





## **SERIES 904**

# **INSTALLATION & SPECIFICATION GUIDE**

**ITEM NO: A1030-7011**  
**REVISION DATE: 05/05**

Microframe Corporation  
604 S. 12th Street  
Broken Arrow, OK 74012

Tel: (918) 258-4839  
Toll Free: 1-800-635-3811  
Website: [www.microframecorp.com](http://www.microframecorp.com)  
E-mail: [support@microframecorp.com](mailto:support@microframecorp.com)

## Limited Warranty Agreement

Your Microframe System is warranted against failure due to defects in workmanship or material for a period of one (1) year from the date of purchase. Microframe Corporation will repair or replace any defective unit. Obvious abuse or mishandling of the unit is NOT covered by this warranty.

## Merchandise Return

If your Unit does not work satisfactorily, please give us a call. We may be able to clear up the problem by phone. If it becomes necessary to return your Unit to the factory, please observe the following.

1. Place Unit in a sturdy box with sufficient packing material.
2. If requested, include the power supply. It is not necessary to return the cable and connectors unless they are the problem.
3. Return the system insured and prepaid since we are not responsible for shipping damages and losses on returned Units.

## Warranty Service

For warranty service, please contact Microframe at 1-800-635-3811. A technician will gladly assist you.

## Assistance

For any product assistance or maintenance help, contact Microframe by either calling 1-800-635-3811 or emailing us at [support@microframecorp.com](mailto:support@microframecorp.com).

## Safety

Do not install substitute parts or perform any modification to the product without first contacting Microframe.

## Warning

All power transformers, line cords, and electrical equipment should be kept out of the reach of children and away from water. (If you are installing cable in an air plenum area, such as a drop ceiling used for air return, you must use plenum-rated cable. The cable supplied from Microframe is rated CL2 and is approved for installation everywhere indoors except plenum areas.)

## Life Support Policy

**Microframe's products are not authorized for use as components in life support devices or systems without the express written approval of the president of Microframe Corporation.** As used herein:

1. Life support devices or systems are defined as systems which support or sustain life, and whose failure to perform when properly used in accordance with instructions for use provided in the labeling, can be reasonably expected to result in a significant injury to the user or any one depending on the system.
2. A critical component is any component of a life support device or system whose failure to perform can be reasonably expected to cause the failure of the life support device or system, or to affect its safety or effectiveness.

## Disclaimer

We are constantly striving to improve our products. Due to this, specifications are subject to change without notice.

# TABLE OF CONTENTS

<b>MODEL 904 SPECIFICATIONS</b> .....	<b>6</b>
<b>MODEL 920, 930, &amp; 940 SPECS</b> .....	<b>7</b>
<b>MODEL 1030 SPECIFICATIONS</b> .....	<b>8</b>
<b>MODEL 941 and 942 SPECIFICATIONS</b> .....	<b>9</b>
<b>1 PRE-INSTALLATION PROCEDURES</b> .....	<b>10</b>
1.1 INSTRUCTIONS FOR USE.....	10
1.2 TEST KEYPAD .....	10
1.3 TEST KEYPAD AND CABLE .....	10
1.4 TEST KEYPAD, CABLE, DISPLAYS .....	10
<b>2 INSTALLATION PROCEDURES</b> .....	<b>11</b>
2.1 KEYPAD INSTALLATION .....	11
2.2 DISPLAY INSTALLATION.....	11
2.3 CABLE INSTALLATION.....	11
2.4 DISPLAY CONNECTION.....	12
<b>3 OPERATION</b> .....	<b>13</b>
3.1 INSTRUCTIONS FOR USE.....	13
3.2 NORMAL MODE.....	13
3.3 ENTER MODE.....	13
3.4 DELETE MODE.....	13
3.5 MULTIPLE PAGING.....	13
3.6 MULTIPLE OUTPUTS .....	13
3.7 MULTIPLE INPUTS .....	13
3.8 POWER CONNECTION.....	13
3.9 FUSE .....	13
3.10 PROGRAMMING OPTIONS.....	13
3.11 OPTION CONNECTIONS.....	14
<b>4 DISPLAY OPERATION</b> .....	<b>15</b>
4.1 POWER .....	15
4.2 MAXIMUM NUMBER OF DISPLAYS .....	15
4.3 USING 2-, 3-, and 4-DIGIT DISPLAYS.....	15
4.4 SYSTEM SIGNAL CONNECTION.....	15
<b>VISUAL-PAGER CONNECTION DIAGRAM</b> .....	<b>16</b>
<b>DETAILED VISUAL-PAGER CONNECTION</b> .....	<b>17</b>
<b>MODEL 1030 INSTALLATION INSTRUCTIONS</b> .....	<b>18</b>
<b>MULTIPLE KEYPAD CONNECTION</b> .....	<b>19</b>
<b>MAXIMUM CABLE LENGTH TABLE</b> .....	<b>20</b>
<b>SOLDERING RCA CONNECTORS - RG59/U CABLE</b> .....	<b>21</b>
<b>REMOTE DISPLAY MOUNTING TEMPLATES</b> .....	<b>22</b>
<b>5 PROGRAMMING OPTIONS</b> .....	<b>23</b>
<b>EXPLANATION OF ERROR CODES</b> .....	<b>24</b>
<b>TROUBLESHOOTING CHART</b> .....	<b>24</b>



# MODEL 904 SPECIFICATIONS

## Keypad

### Features

The Model 904 Keypad is designed to operate with the 920, 930, or 940 Displays. The Keypad accepts up to four digit numbers. User options include Variable Rollover Time, Automatic Delete, and Manual Advance.

### Operation

Once a number is entered into the Keypad, the number is sent immediately to the Display. The Keypad will store up to 30 four-digit numbers and display them



Microframe® Model 904 Keypad

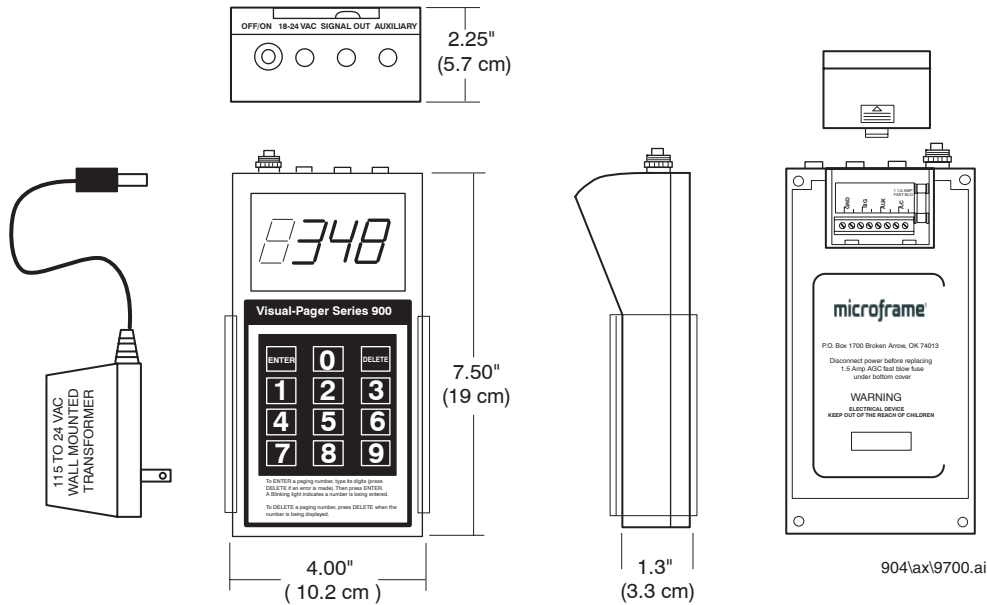

### Model 904 Specifications

Local Keypad Display .....	Built-in LED Readout
Maximum Number of Digits .....	Four Digits
Maximum Number of Keypads .....	Up to 32 Keypads
Maximum Numbers Stored .....	30 Four-Digit numbers
Power Input Requirements .....	24VAC 1.2A supplied by transformer which requires 115 Volts AC @ .72 Amps.
Fuse Requirements .....	1.5 Amp GMA (5mm x 20mm) fast-acting fuse
Weight .....	.075 lb (0.4 kg) with transformer 2.25 lb (1.0 kg)

Support and Sales  
**800-635-3811**

Microframe® Corpora-  
tion  
www.microframecorp.  
com



# MODEL 920, 930, & 940 SPECS

## Remote Displays

### Features

Each Display has 5.5 inch tall digits viewable from up to 125 feet and is encased in an aluminum extruded cabinet.

### Operation

The 920, 930, and 940 Remote Displays are designed to operate with the Model 904 Keypad, Model 906 Keypad or Model 6200 Timer Keypad. The Remote Display receives power and signal from a single cable connected to the Keypad and is turned on or off with the Keypad power switch.



Microframe® Model 940 Display

### Models 920, 930, and 940 Displays

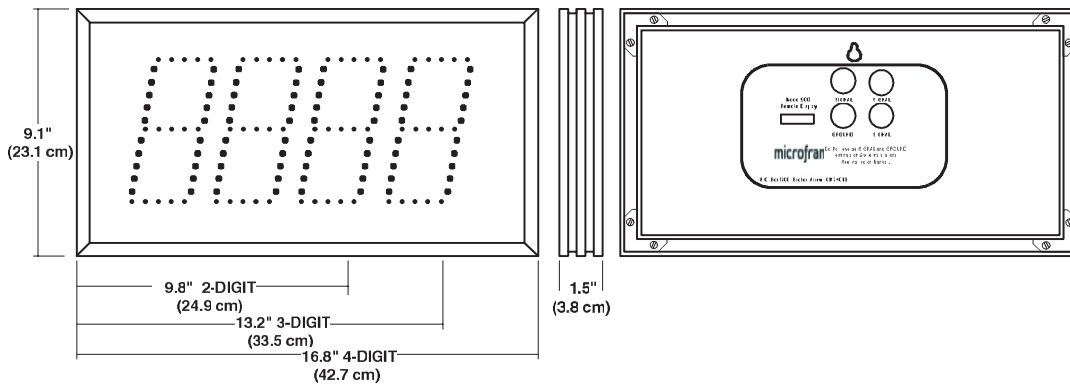

### Model 920, 930, and 940 Specifications

Remote Display .....	Wall mount 5.5" tall LED display.
Maximum Distance from Keypad .....	2,000 feet = 1 Display 300 feet = Full Load of Displays
Maximum Number of Displays.....	Up to 12 two-digit displays, 9 three-digit displays, or 7 four-digit displays without an additional booster amp.
Power Input Requirements .....	Power supplied by keypad.
Character Viewing Distance .....	125 feet in normal light.
Case .....	Aluminum case with Plexiglas faceplate
Weight .....	2-digit, 2.5 lbs (1.1 kg), 3-digit, 3 lbs (1.4 kg) .....4-digit, 3.5 lbs (1.6 kg)

**Support and Sales**  
**800-635-3811**

Microframe® Corpora-  
tion  
www.microframecorp.  
com



# MODEL 1030 SPECIFICATIONS

## Remote Display

### Operation

The Model 1030 Remote Display is designed to operate with the Microframe Model 904 Keypad to display 3-digit numbers.



Microframe® Model 1030 Display

## Model 1030 Remote Display

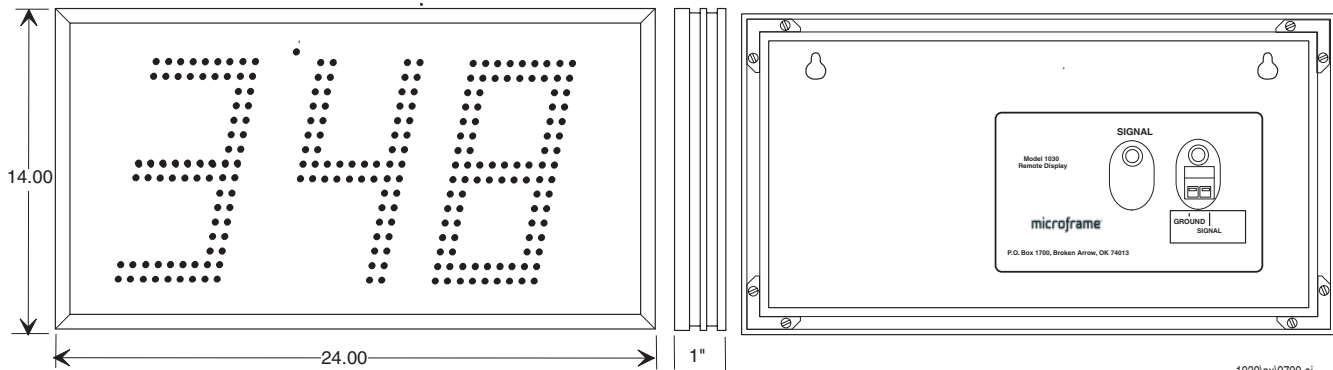

1030.lax\9700.ai

### Model A1030 Specifications

Remote Display .....	Wall Mount 10-Inch (25.4 cm) High Brightness LED Display
Power Input Requirements .....	24 Volts AC or DC
Maximum Number of Digits .....	3 Digits
Character Height .....	10 Inch (25.4 mm)
Character Viewing Distance .....	300 Feet Indoor
Weight .....	8 lbs
Enclosure Specifications .....	Red Plexiglas Cover with Aluminum Extrusion

**Support and Sales**  
**800-635-3811**

Microframe® Corporation  
[www.microframecorp.com](http://www.microframecorp.com)

P.O. Box 1700  
 Broken Arrow, OK 74013



# MODEL 941 and 942 SPECIFICATIONS

## Mini Remote Display

### Features

The Model 941 and 942 Mini Displays feature approximately 1 inch tall digits viewable from up to 30 feet. The Model 942 Display is double sided and can be viewed from either side.

### Operation

The Model 941 Desktop Remote Display is designed to operate with the Microframe Model 6200 Timer or Model 904 Keypad to provide a Remote Display of data entered into these products. The Model 941 Display receives its power and signal from a single cable connected to the Keypad and is turned on or off with the Keypad power switch.



**Microframe® Model 941 and 942 Displays**

## Model 941 and 942 Mini Displays

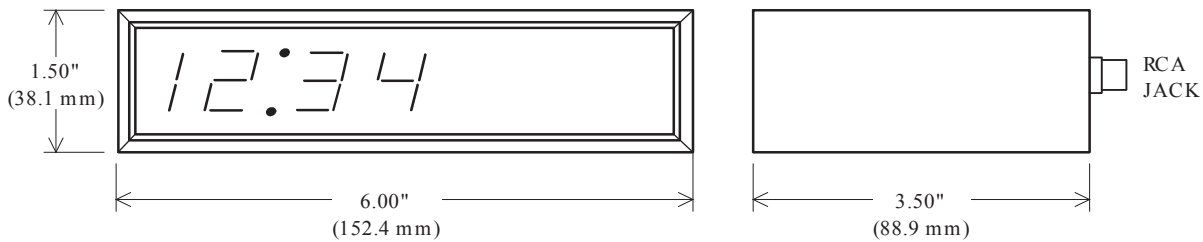

### Model 941 and 942 Specifications

Remote Display .....	Desktop .8 Inch (20.3mm) LED Display
Maximum Distance from Keypad.....	2,000 feet = 1 Display
	300 feet = Full load of 8 Displays
Power Input Requirements .....	Power Supplied by Keypad
Maximum Number of Digits .....	4 Digits
Character Height .....	1 Inch (20.3 mm)
Character Viewing Distance .....	30 Feet (6 meters)
Case .....	ABS Plastic
Weight .....	1 lb (.45 kg)

**Support and Sales**  
**800-635-3811**

Microframe® Corporation  
www.microframecorp.com

P.O. Box 1700  
Broken Arrow, OK 74013

# 1 PRE-INSTALLATION PROCEDURES

Before permanent installation, we recommend that you test your entire system in one room on a table or floor. This will be of great benefit in troubleshooting if you should have any problem after installing the system.

## 1.1 INSTRUCTIONS FOR USE

The Model 904 Keypad has its own local easy-to-read display. It has three different modes: Normal Mode, Enter Mode and Delete Mode. The user may enter the Programming Mode to setup user-programmable options. Multiple Displays or Keypads may be added at any time.

## 1.2 TEST KEYPAD

Connect the wall mount transformer to the Model 904 Keypad at the **18-24 VAC connector**. Turn power "ON" and enter a number. If the number appears on the local Keypad display, the Model 904 is working correctly.

## 1.3 TEST KEYPAD AND CABLE

Turn power "OFF" and select the cable to be used between the Keypad and the LED Display. Connect one end of this cable to the Keypad (see VISUAL PAGER CONNECTION DIAGRAM). Make sure the other end is not touching together, then turn power "ON." Type in a number and press "ENTER." If the message **E1** or **E2** appears in the local Keypad display, there is a short in the cable and needs to be repaired before proceeding. Otherwise, if the system appears to work correctly, then continue.

## 1.4 TEST KEYPAD, CABLE, DISPLAYS

Turn power "OFF." Connect the other end of the cable to the Display and verify that it works by turning the power "ON" and typing in a number and pressing "ENTER." If the message **E1** or **E2** appears, there is a short in the Display. Should the message **E3** appear, the Model 904 Keypad has failed and should be returned to the factory for service. If the Remote Display does not show the numbers once they are entered and there is no error code displayed, then the signal cable is *open*. An *open* cable means it is not making a connection, or it has a broken wire.

## 2 INSTALLATION PROCEDURES

### 2.1 KEYPAD INSTALLATION

Select a location that is convenient but not in the way of traffic. The Model 904 Keypad may be mounted on a table top or on the wall. Locate the Keypad so that the cord from the wall-mount transformer is not accessible to children or will not present a safety hazard. The installation location must be within 5 feet of an AC power outlet so that the cord may easily reach the Keypad.

Place the Keypad in the enclosed plastic wall mounting bracket, if desired, and then locate the desired mounting location on a table top or wall and mark the position. Slide the Keypad out of its mounting bracket and attach bracket using screws supplied. Once screws are screwed in flush with back of bracket, slide Keypad into bracket. The Keypad is easily removed, if necessary.

Install the Keypad and connect to AC power. **DO NOT** attach the cable that runs to the Remote Display(s) yet. Test for operation by entering a number and observing this number in the built-in display of the Keypad. This verifies that the system is working. If the unit did not work, refer to the Troubleshooting section. Now turn power "OFF."

Only the Keypad needs an AC outlet for the wall mount transformer which powers the entire system.

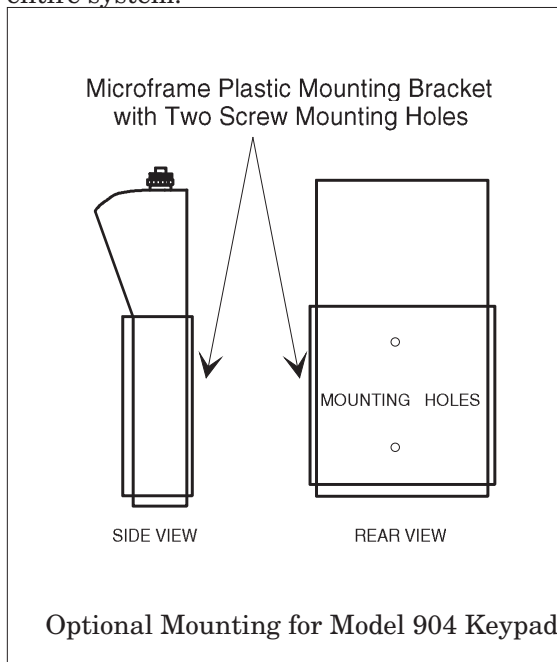

### 2.2 DISPLAY INSTALLATION

The Remote Display will have optimum visibility when mounted within three or four feet of eye level.

The Remote Display may be hung on a screw anchored in the wall. First, place the hole template on the wall and mark the location for the mounting screw through the template. Next, punch one hole for the input cable from the Keypad and a second hole for the cable to the next Display, if applicable. **Do not** connect the cable to either Display yet.

### 2.3 CABLE INSTALLATION

A single signal cable must be installed between the Keypad and the Remote Display. For proper cable selection, please refer to the **MAXIMUM CABLE LENGTH TABLE** on page 16. This will allow the longest distance and the most reliable operation.

The Visual-Pager System uses an 18 AWG wire pair. Cable supplied by Microframe has the ends prepared ready to connect to the Keypad and Remote Display. (See diagrams on pages 14 and 15.)

If you wish to use RCA phono connectors, refer to the instructions for **SOLDERING RCA PHONO CONNECTORS** (page 17) on to your own cable. Please read instructions before installing the RCA phono connectors. If you have soldered your own cable connectors, you should test the cable for shorts with a short tester or Ohm meter (after the cable is installed and before connecting to the Remote Display).

Next, connect the cable to the Keypad connector marked "Signal Out." Turn "ON" the power switch. When the Keypad power LED (small red light inside the local display) comes on, type in a number and press "ENTER." If Error Codes E1 or E2 appear, then there is a short in your cable and it needs to be repaired before proceeding.

Next, turn power "OFF" and proceed to **Step Four: Display Connection.**

If you turn your Keypad "ON" and you do not see a power light, you may have blown a fuse. Turn power "OFF" and remove transformer from wall outlet.

You may gain access to the fuse by removing the small slide-on cover on the rear cover of the Keypad. Replace only with fuse as stated in 904 SPECIFICATIONS (page 4) to prevent permanent damage to the Keypad.

**IMPORTANT!**  
UNPLUG TRANSFORMER FROM OUT-  
LET BEFORE REPLACING FUSE.

## 2.4 DISPLAY CONNECTION

After the cable is installed and connected to the Keypad and tested, turn the power "**OFF**" and connect the cable to the Remote Display. Turn the Keypad power "**ON**." Both the local Keypad display and the Remote Display should be blank. Now type in a number and press "**ENTER**." The number you enter should appear on the Keypad display and the Remote Display. If nothing is shown on the Remote Display, then the signal cable is *open*. (This means it has not made connection or it has a broken wire.) Check the connectors and replace if necessary. If Error Code **E3** appears, the Model 904 needs to be returned to the factory for service.

Return the warranty card immediately to register your purchase and begin your warranty period. Registering will not affect your right to return the system during a 30-day trial period.

**CAUTION**  
24-VAC VOLTAGES ARE PRESENT  
UNDER THE SMALL SLIDE-ON COV-  
ER.

## 3 OPERATION

### 3.1 INSTRUCTIONS FOR USE

The Model 904 Keypad has its own local easy-to-read display. It has three different modes: Normal Mode, Enter Mode and Delete Mode. The user may enter the Programming Mode to setup user-programmable options. Multiple Displays or Keypads may be added at any time.

### 3.2 NORMAL MODE

While in normal mode, the local Keypad display shows the same numbers as the Remote Display.

### 3.3 ENTER MODE

When a number button is pressed, the Keypad will go into enter mode and the "ENTER" light will flash. While in enter mode, the number to be paged will be shown only on the Keypad display. Continue to press number buttons until the complete number to be paged is shown. Then press "ENTER" to display the paging number on the 920, 930 or 940 Remote Display. When "ENTER" is pressed, the Keypad will leave the enter mode and the new number will be placed in sequence with any other numbers displayed on the Remote Display. If you make an error while entering a number, press "DELETE."

### 3.4 DELETE MODE

To delete a paging number, press "DELETE" when that number appears on the Display. The next available number will be displayed immediately. You may also delete a number at any time by typing the number and pressing "DELETE."

### 3.5 MULTIPLE PAGING

The Keypad will store up to 30 four-digit numbers and display them sequentially until the operator deletes them. These numbers may be entered one at a time using the instructions above.

### 3.6 MULTIPLE OUTPUTS

The 904 Keypad will drive 12 Model 920, 9 Model 930, or 7 Model 940 Remote Displays up to 3,000 feet from the 904 Keypad provided the recommended wire is used (see Maximum Cable Length Table).

### 3.7 MULTIPLE INPUTS

You may cascade up to 32 Model 904 Keypads on the same common cable connected to the "Signal Out" output from each Keypad. Numbers entered from each Keypad will automatically be combined and displayed in sequence with all the numbers entered from all Keypads. Each Keypad will display all numbers entered from itself as well as all numbers entered from all other Keypads at the same time they are displayed on the Remote Display(s). A number may be deleted by pressing "DELETE" on any Keypad when that number appears in the Keypad display, or by typing in the number then pressing "DELETE."

### 3.8 POWER CONNECTION

Connect the wall mount transformer to an AC outlet and connect the power plug to the connector on the top of the Keypad marked "18-24 VAC." It is recommended that you turn the power off using the "ON/OFF" switch on the Keypad when not in use. This will greatly prolong the life of the system.

**WHEN REPLACING THE FUSE, BE SURE TO DISCONNECT POWER FROM THE AC WALL OUTLET.**

### 3.9 FUSE

The Model 904 Keypad contains a fuse inside the case under the small slide-on cover. *When replacing the fuse, be sure to disconnect power from the AC wall outlet.* Replace only with the fuse size stated in the 904 SPECIFICATIONS; otherwise permanent damage may occur.

### 3.10 PROGRAMMING OPTIONS

The following user programmable options are available in the Model 904 Visual-Pager. See Programming Instructions on page 19.

Option 13....Change Display rotation time from 0 to 9 seconds. When 0 is selected, the Display will only rotate one number each time the DELETE Button is pressed.

Option 14....Automatically delete numbers after a delay of 1 to 9 minutes.

Option 17....Delete Keypad sound.

Option 19....Reset to factory defaults.

Option 21....Cancel number sort

### **3.11 OPTION CONNECTIONS**

The Model 904 Keypad has two optional connections on the 8-pin terminal block located under the small removable cover.

1. **AUX**—Auxiliary connection for use with the extra cost Remote Delete Option.

2. **A/C**—Remote 24 VAC Input used when a transformer other than the wall mounted one supplied with the system is required, such as an attic-mounted transformer installation.

## 4 DISPLAY OPERATION

- | **5.5" LED Numbers**
- | **2-, 3-, or 4-Digit Remote Displays**
- | **No AC Power Required**
- | **Single Cable Installation**
- | **Simple Surface Mount**

### 4.1 POWER

The Model 920/30/40 Remote Display is designed to operate with the Model 904 Keypad. When the Keypad is turned off, the Model 920/30/40 Remote Display is automatically turned off. An AC power outlet is not used at the Remote Display.

### 4.2 MAXIMUM NUMBER OF DISPLAYS

The 904 System can power up to seven Model 940, nine Model 930, or twelve Model 920 Remote Displays. **These Display limits still apply for systems which have multiple Keypads.**

However, if additional Remote Displays are needed for a system, a Model 160 Booster Amp may be added.

### 4.3 USING 2-, 3-, and 4-DIGIT DISPLAYS

The Keypad will accept up to four digits. However, only the last two or three digits entered will be displayed on a Model 920 (2-digit) and Model 930 (3-digit) Remote Display respectively.

### 4.4 SYSTEM SIGNAL CONNECTION

Refer to the connection diagram on page 14 for Remote Display connection. Connect the system with 16 or 18 AWG paired wire by using the 8-pin terminal block located under the small slide-on cover on the back of the Model 904 Keypad. If you are using the RCA connectors, then connect the cable to the Keypad where it is marked "**Signal Out.**"

**NOTE:** The "**Auxiliary Connector**" should not be used with the 900 Series Displays.

For 16 or 18 AWG paired wire installations,

use the two-conductor terminal block located inside the rear cover. Be very careful to observe **SIGNAL** and **GROUND** polarity. There is a second set of connectors to run another wire to the next Display, if needed.

If you are using RCA connectors, then connect the coaxial cable to either "**Signal**" connector on the Model 920/30/40 Remote Display. To add a second Remote Display, connect one end of the signal cable to the other RCA phono connector on the first Remote Display and the other end to either connector on the next Remote Display.

# VISUAL-PAGER CONNECTION DIAGRAM

## Using 16 or 18 AWG Paired Wire

The VISUAL-PAGER may be connected with common 16 or 18 AWG paired wire utilizing the terminal blocks located at the back of the remote displays and under the small slide-on cover of the Model 904 Keypad.

**Model 930 Remote Display**

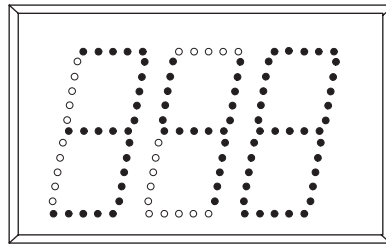

REAR VIEW

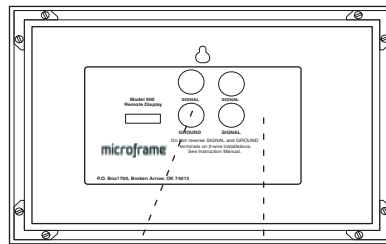

GROUND SIGNAL

**Model 920 Remote Display**

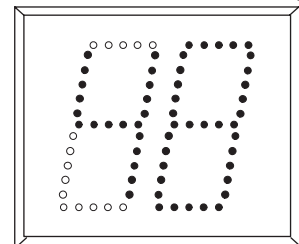

REAR VIEW

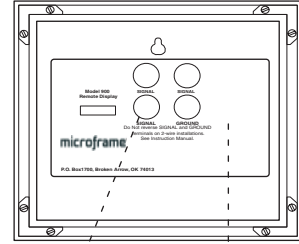

SIGNAL GROUND

SEE NOTE

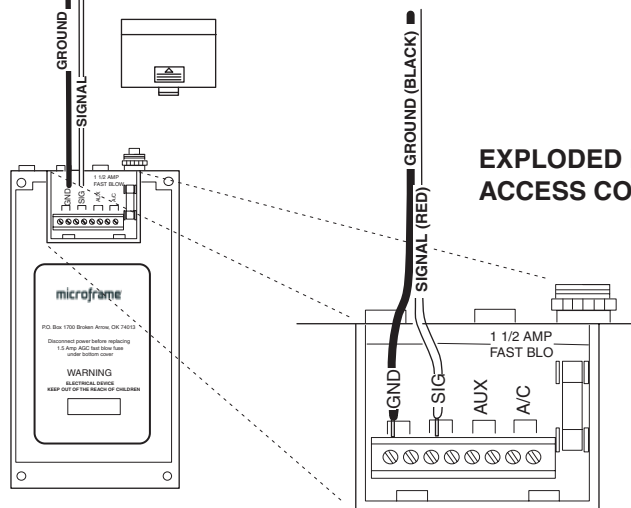
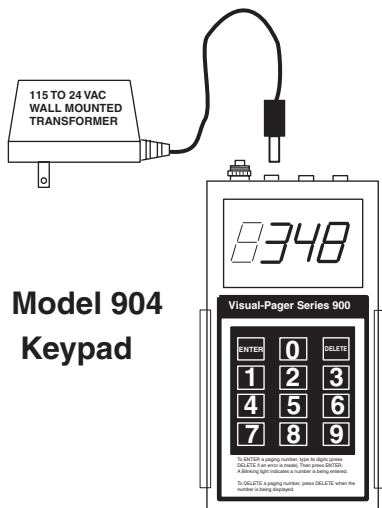

904\ax\9702.DRW

**NOTE:** The Model 920 **SIGNAL** connection is on the Left and **GROUND** is on the Right. On the Model 930, 940 and 960, the **SIGNAL** connection is on the RIGHT and **GROUND** is on the

# DETAILED VISUAL-PAGER CONNECTION

## STEP 1:

Remove slide-on cover.

## STEP 2:

Remove 1.5" insulation from cable jacket and separate wires.

Strip 1/4" insulation from each wire and pre-form wires as shown.

## STEP 3:

Insert Black Wire in one of the terminals marked GND.

Insert Red Wire in one of the terminals marked SIG.

Tighten terminal screws using a 1/8" slotted screwdriver.

## STEP 4 ( If required ):

If a second set of wires are required at the Keypad, repeat Step 3 being careful not to reverse the SIG and GND connections.

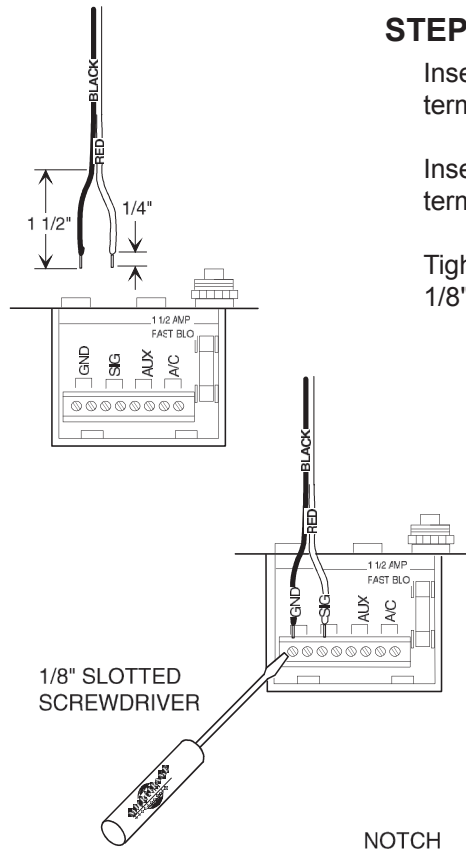
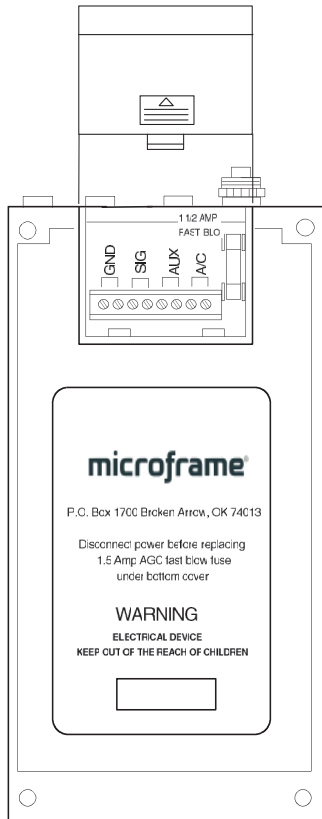

1/8" SLOTTED SCREWDRIVER

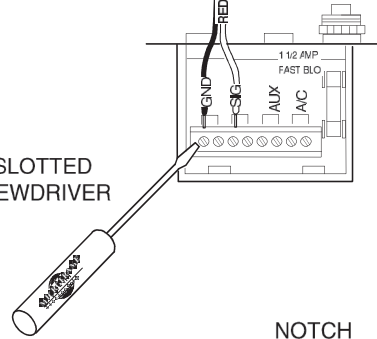

NOTCH

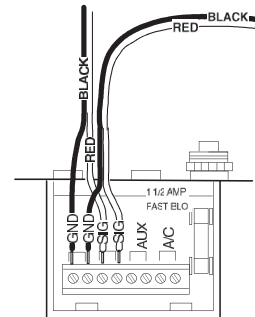

## STEP 5:

Install slide-on cover being careful to first form wires so the Ty-wrap is inside the case as shown. The slide-on cover has a notch for the wires to

Ty-Wrap

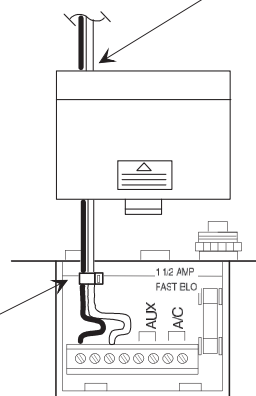

# MODEL 1030 INSTALLATION INSTRUCTIONS

The Model 1030 Remote Display can be wired with either 18 AWG Paired Wire or RG-59/U Cable. This diagram shows the 18 AWG Paired Wire installation where SIGNAL and GROUND connection polarity must be observed. For RG-59/U installation, simply plug the RCA connectors into the receptacles marked SIGNAL on the keypad and display.

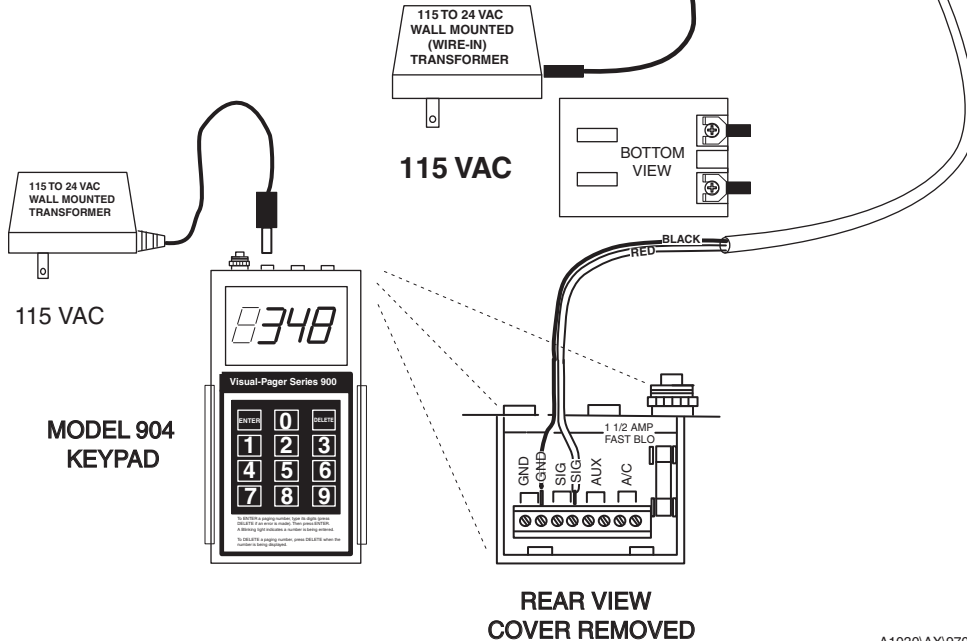
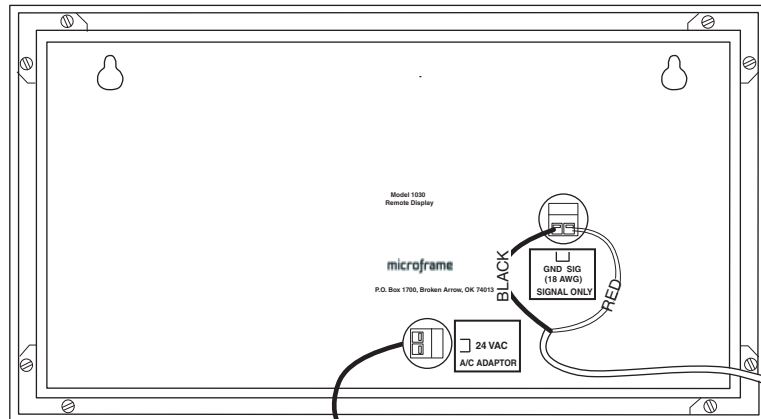
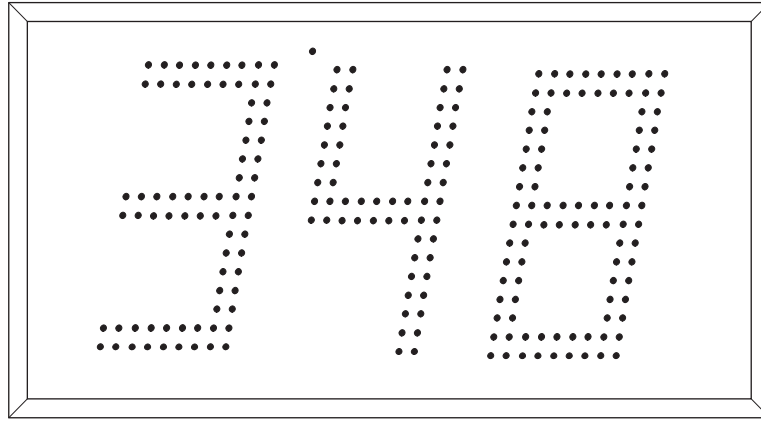

# MULTIPLE KEYPAD CONNECTION

You may connect your second Keypad as shown in the examples below:

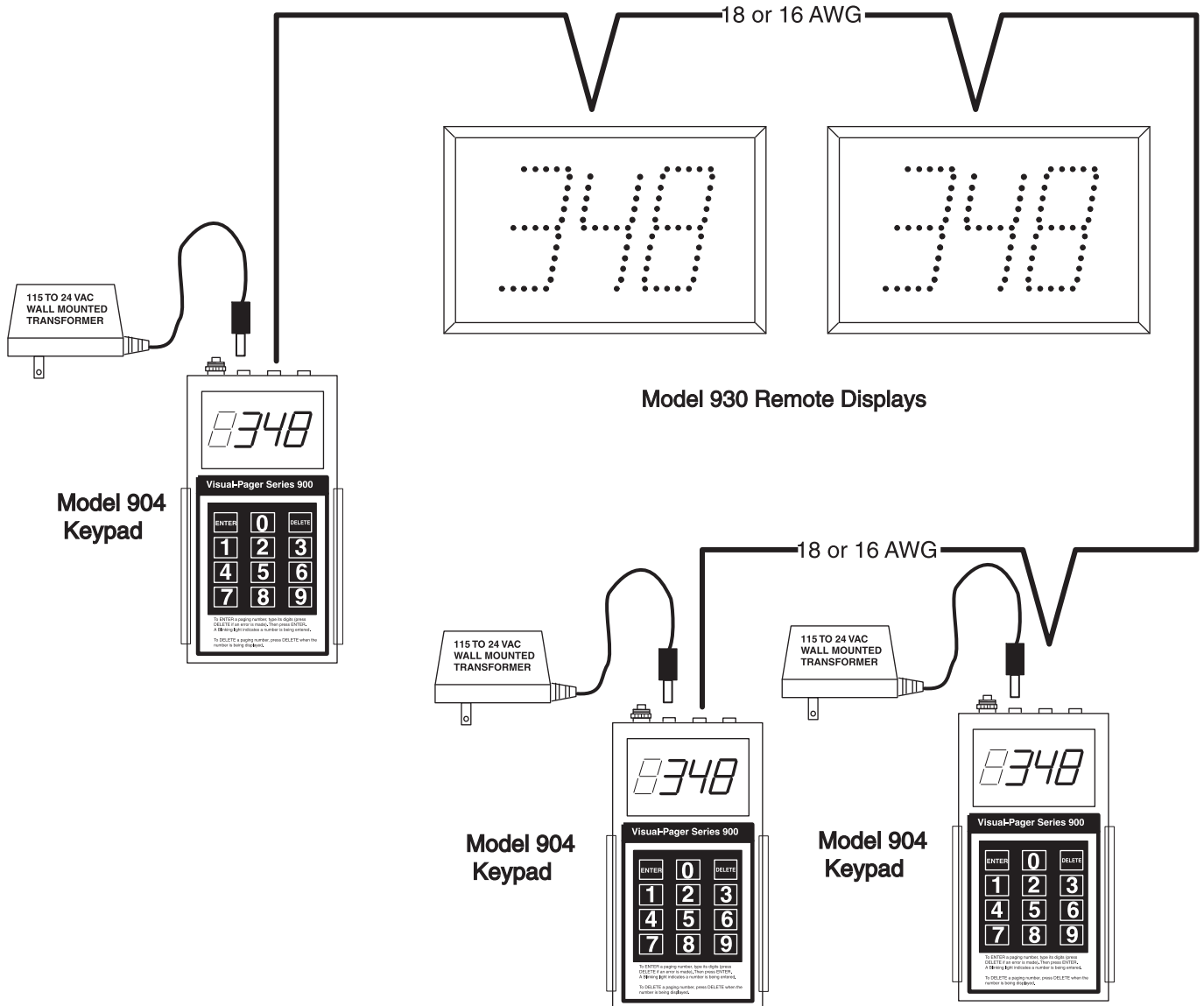

904\ax19701.DRW

Model 904 Keypads may be connected at any point along the signal cable. The 900 Series VISUAL-PAGER will work as long as one of the Model 904 Keypads is turned on. Other Model 904 Keypads may be turned on at any time; however, they should not be turned OFF as long as numbers are being displayed. (Refer to the Maximum Cable Length Chart for proper cable selection.) The system may be connected in many other configurations provided they are all hooked together and the **SIGNAL/ GROUND** polarity is maintained (see Visual-Pager Connection Diagrams).

## MAXIMUM CABLE LENGTH TABLE

The following chart shows the maximum number of 2-, 3-, or 4-digit Remote Displays that can be installed per cable length indicated. The cable length can be increased by simply putting fewer Remote Displays on EACH CABLE connected to the Model 904 Keypad. For example, when using 18 AWG wire you can install a maximum of four Model 940 (4-digit) Remote Displays up to 1,000 feet from the Keypad on a single cable. However, if greater distance is required, simply use 16 AWG wire from the Keypad. You can now install four Model 940 (4-digit) Remote Displays up to 1,600 feet from the Keypad. The TOTAL CABLE LENGTH (Sum of length of all cables in the system) should not exceed 10,000 feet.

### CABLE LENGTH CHART FOR 18 AWG WIRE, OR 16 AWG WIRE

<b>Model 920 2-Digit Displays</b>		
# of Displays	Distance	
	18 AWG	16 AWG
1	2000	2000
2	2000	2000
3	2000	2000
4	2000	2000
5	1500	2000
6	1100	1800
7	800	1300
8	600	1000
9	400	700
10	300	500
11	200	400
12	100	100

<b>Model 930 3-Digit Displays</b>		
# of Displays	Distance	
	18 AWG	16 AWG
1	2000	2000
2	2000	2000
3	2000	2000
4	1500	2000
5	1000	1600
6	700	1100
7	500	800
8	300	500
9	100	200

<b>Model 940 4-Digit Displays</b>		
# of Displays	Distance	
	18 AWG	16 AWG
1	2000	2000
2	2000	2000
3	1600	2000
4	1000	1600
5	600	1000
6	400	700
7	200	400

# SOLDERING RCA CONNECTORS - RG59/U CABLE

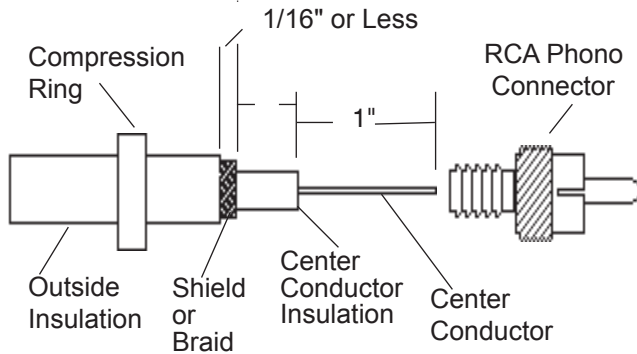

If you are soldering on your own RCA connectors, please read these instructions. They show how to make a clean, reliable non-shorting connection. If you don't have soldering experience, find someone who does. It will make the job much easier. Slip compression ring over RG59/U cable and then trim cable to the dimensions shown.

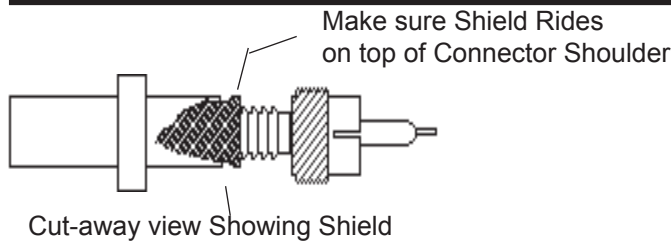

Slide the RCA phono connector down over the cable, making sure the braided shield slides on the outside of the connector flange.

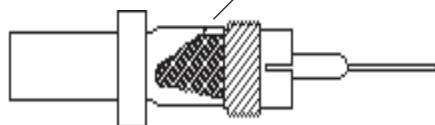

Slide RCA phono connector on cable until cable fits snugly against connector.

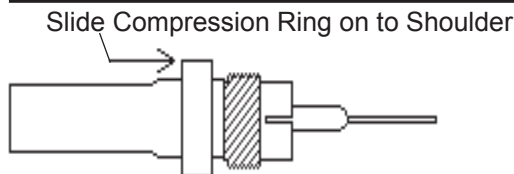

Slide crimp ring toward connector and place in the approximate center of the shoulder.

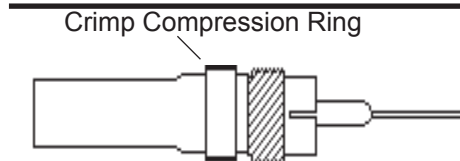

Crimp ring down on cable securely with crimp ring tool purchased from Radio Shack.

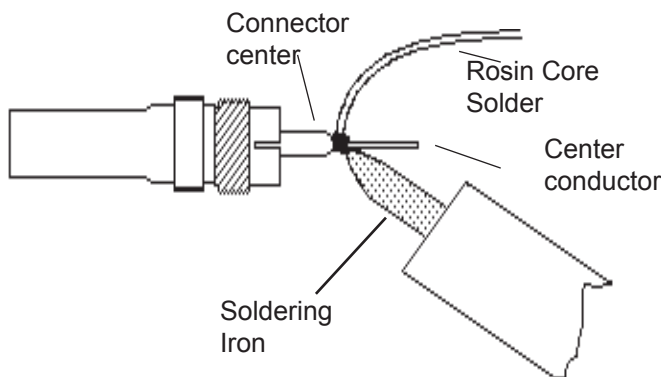

Now, solder center conductor by carefully heating center conductor with soldering iron and applying solder as shown. Do not apply soldering iron to connector center because it will leave globs of solder. After heating for several seconds, the solder should draw up into the center of the connector. Use only enough solder to fill the center of the connector 1/8 inch back from the end you are soldering.

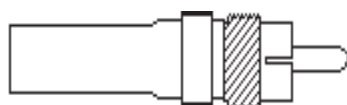

Allow 15 seconds of cooling without moving the cable. Then you may trim the excess center conductor with a pair of wire cutters.

# REMOTE DISPLAY MOUNTING TEMPLATES

## Model 920 Display

First, make a copy of this template. Then place template on wall with words facing toward you and start screw in the center of the screw hole. Leave screw head out 1/4" from wall surface. Locate cable hole(s) by marking the wall through the template for the type of cable being used. Remove template and drill 1" hole in wall for cable. For Remote Displays where a second cable is connected, mark both holes while template is on the wall.

### 920 REMOTE DISPLAY DRILL TEMPLATE ( TOP OF DISPLAY )



MOUNTING HOLE FOR  
920 REMOTE DISPLAY

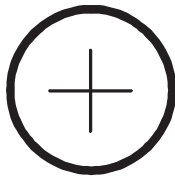

RG-59/U  
CABLE

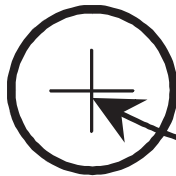

USE EITHER OF THESE TWO  
HOLES FOR **RG-59/U** CABLE

BRING OUT CABLE HERE

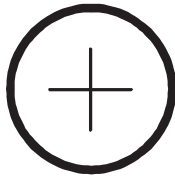

18-16 AWG  
CABLE

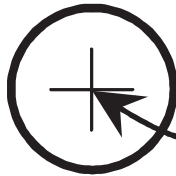

USE EITHER OF THESE TWO  
HOLES FOR **18-16 AWG** CABLE

BRING OUT CABLE HERE

9X09801

## Model 930 and 940 Display

First, make a copy of this template. Then place template on the wall with words facing toward you and start the screw in the center of the screw hole. Leave screw head out 1/4" from the wall surface. Locate cable hole by marking the wall through the template for the type of cable being used. Remove template and drill 1" hole in the wall for cable. For Remote Displays where a second cable is connected, mark both holes while template is on the wall.

### 930 AND 940 REMOTE DISPLAY DRILL TEMPLATE



MOUNTING HOLE FOR  
940 REMOTE DISPLAY

MOUNTING HOLE FOR  
930 REMOTE DISPLAY



USE EITHER OF THESE TWO  
HOLES FOR **RG-59/U** CABLE

BRING OUT CABLE HERE



USE EITHER OF THESE TWO  
HOLES FOR **18-16 AWG** CABLE

BRING OUT CABLE HERE

9X09801

## 5 PROGRAMMING OPTIONS

### 5.1 PROGRAMMING MODE

To enter the Programming Mode, HOLD the "ZERO" key down when turning the Model 904 Keypad "ON." The Model 904 will display the Serial Number. Release the "ZERO" key; you are now in the programming mode. To change any of the factory selected defaults, select the option number listed below and press that number. To exit the programming mode, simply press "DELETE." Should the error code "E4" appear at any time, you may return to the factory defaults by pressing "19" and starting over.

### 5.2 OPTION 1: DISPLAY REVISION NO.

Once in the Programming Mode, press "ENTER" on the Keypad and the current Model 904 software revision number will be displayed: for example, 20, 21, 22, etc. To continue in the Programming Mode, press one of the Option Numbers listed below, or press "DELETE" to exit the Programming Mode.

### 5.3 OPTION 13\_1-9: ROTATION TIME

While in the Programming Mode, press "13" on the Keypad. The number 13\_3 will be displayed indicating that your Model 904 Keypad was shipped with a pre-programmed Display rotation time of 3 seconds. Each number entered into the system will be displayed for 3 seconds before rotating to the next entered number. Should you wish to increase or decrease the time between displayed numbers, select and enter any number from 1 to 9 seconds on the Keypad and press "ENTER." The Display rotation will be the number of seconds (1- 9) you selected.

### 5.4 OPTION 13\_0: MANUAL ADVANCE

It is also possible to program your Model 904 to store a series of numbers then display them in sequential order on demand. It will start with the first number entered and rotate to the next number each time the "DELETE" key is pressed. This option is useful in a song service for displaying the next song without the system automatically rotating the songs. To select this feature, press "13\_0," "ENTER" on the Keypad. The Display rotation time is now Zero or turned OFF. To reset the Display rotation time, see Option 13 above.

(NOTE: To display numbers as they were entered you must turn off the sort routine using OPTION 21.)

### 5.5 OPTION 14\_0-9: AUTO DELETE

The Model 904 Keypad will normally display any entered number until manually deleted by pressing the "DELETE" key. The Auto Delete Option will automatically delete each entered number after 1 to 9 minutes. Should you wish to enable the Auto Delete Option, enter the Programming Mode, and then press "14" on the Keypad. The Model 904 Keypad reads 14\_0 indicating the Auto Delete is "OFF." Select and press any number from 1 to 9 minutes and press "ENTER." The Model 904 will now Automatically Delete each entered number after the minutes entered have elapsed, for example, 14\_3 = 3 minutes.

### 5.6 OPTION 17\_0-1: KEYPAD BEEPER

The Model 904 has a built-in beeper that "clicks" every time a keyboard entry is made. If you wish to disable this feature, press "17" on the Keypad while in the Programming Mode, then press "1," "ENTER." The beeper is now disabled. To reactivate the beeper, simply press "17\_0" "ENTER" while in the Programming Mode.

### 5.7 OPTION 19\_: RESET TO FACTORY SETTINGS

At any time while in the Programming Mode, the Model 904 can be reset to the Factory Options by pressing "19." The local Keypad display will blink once and then display the current revision number indicating the Factory Options have been reset.

### 5.8 OPTION 21\_0-1: NUMBER SORT

This option lets the user decide whether or not to display the numbers in numerical order or the order in which they were entered. To disable the number sort, press "21\_1" on the Keypad while in the Programming Mode, then "ENTER." The sort is now disabled. This will set the number option to display the numbers in the order that they were entered. To enable the sort press "21\_0" "ENTER" and the sort routine will again sort the numbers.

## EXPLANATION OF ERROR CODES

There are four error conditions that will cause an Error Code to appear on the Model 904 Keypad display. It will be of great assistance in troubleshooting the system if you will note the displayed code when calling the factory for assistance. Call 1-800-635-3811 for technical support.

ERROR MESSAGE	CAUSE
<b>E1</b> —SHORTED CABLE	The cable is shorted within 100 feet of the Model 904 Keypad.
<b>E 2</b> —SHORTED CABLE	The cable is shorted greater than 100 feet from the Keypad, probably at the remote display.
<b>E 3</b> —NO SIGNAL OUTPUT	The output transistor is blown and there are no numbers shown on the Remote Displays. <b>DO NOT ATTEMPT TO CORRECT THIS PROBLEM.</b> Return the Model 904 Keypad to the factory.
<b>E4</b> —PROGRAMMING ERROR	There is a programming error. Return the Model 904 Keypad to Factory Defaults by <b>PRESSING 19</b> in the Programming Mode (see <b>Programming Instructions</b> for more details).

## TROUBLESHOOTING CHART

SYMPTOM	POSSIBLE CAUSE	CURE
Keypad display and Remote Display are not working.	Keypad is not connected to power. Power supply is bad or Keypad fuse blown.	Check AC wall connection or change to another wall outlet. Replace Model 904 Keypad fuse.
Keypad display works but Remote Display does not light up or Remote Display has erratic numbers.	Poor signal connection to Remote Display or no signal connection.	Check signal cable connections or move Remote Display close to the Model 904 Keypad and try with a short cable to prove whether the problem is in the units or in the cable.
Keypad works but Remote Display does not work and Keypad displays E3	Output transistor is blown.	Return Model 904 Keypad to factory.
Model 904 Keypad works until the cable is plugged in, then it displays E1 or E2.	Shorted cable. <b>E1</b> is shorted within 100 ft of 904. <b>E2</b> is a short over 100 ft from 904.	Check connectors for shorts. Repair or replace cable.
Keypad display shows	Programming error.	Reset to Factory Defaults (See Programming Instructions.)